

A comprehensive range of quality pneumatic chain hoists suitable for both industrial and marine environments. Red Rooster pneumatic hoists comply with the European Machinery Directive and are CE marked. Our ISO9001:2008 Quality System is accredited by L.R.Q.A.

Standard Hoist Features:

- Toku rotary vane motor.
- Robust epicyclic gearbox (grease filled and sealed).
- Failsafe automatic internal disc brake
- Choice of pull cord or pendant control.
- Mechanical, upper and lower limit switches.
- Cast steel housing.
- Variable speed.
- Internal silencing down to 75 dBA
- Alloy safety swivel hooks c/w safety catch.
- Load chain of European manufacture EN818/1-7
- Automatic, adjustable load limiter.

Available Options:

- Marine specification
- Special paint systems
- Corrosion protection
- ATEX specification ZONE 1 & 2
- Chain collectors (P.V.C., galvanised or stainless steel).
- Air service units
- Festoon systems
- Radio control
- Main air shut off valve

MODEL	WLL	LIFTING SPEED WITH LOAD	LIFTING SPEED WITHOUT LOAD	AIR CONSUMPTION LIFTING	LOWERING SPEED WITH LOAD	AIR CONSUMPTION LOWERING
	2000kg	3.0 m/min	5.7 m/min	25 l/sec	5.2 m/min	30 l/sec
TCR-2000C2	AIR CONNECTION	MINIMUM HOSE DIAM.	WORKING PRESSURE	CHAIN FALLS	WEIGHT WITH 3M HOL	WEIGHT PER ADDITIONAL METRE HOL
	½" BSP	½" HOSE	6 bar	2	39.7kg	2.2kg

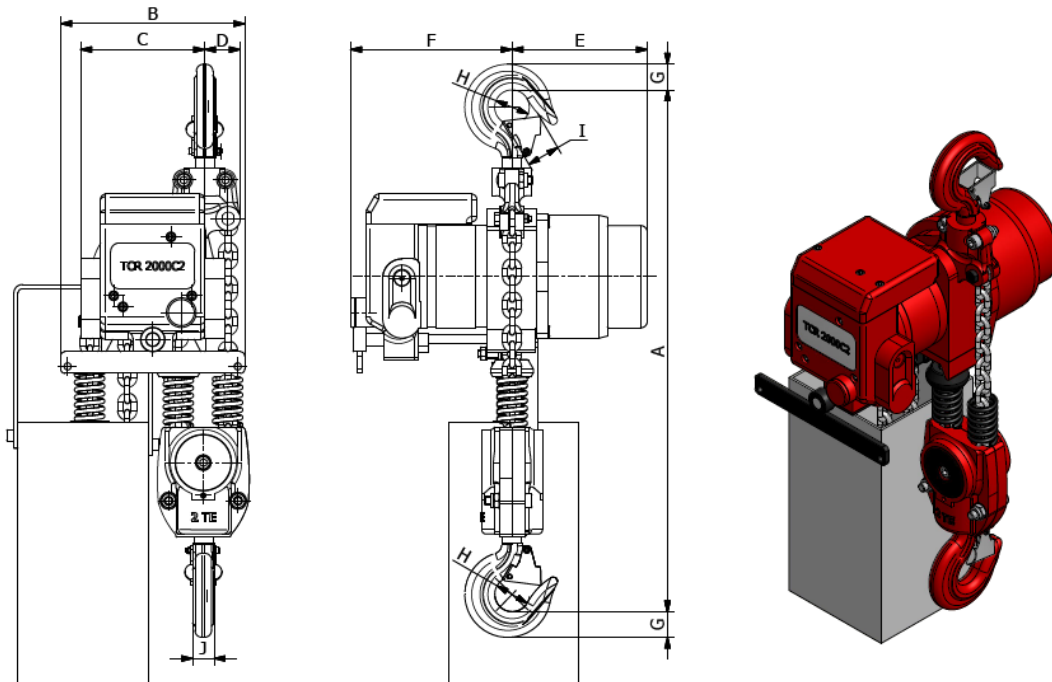

Model	A	B	C	D	E	F	G	HØ	I	J
TCR-2000C2	595	212	143	50	156	186	37	45	29	30

All measurements are in mm

For quotation purposes only. Not drawn to scale. This drawing may not include all options offered on the quotation